



USDOT Tier 1  
University Transportation Center  
on Improving Rail Transportation  
Infrastructure Sustainability and Durability

Final Report UD-13

**NONLINEAR DIMENSION REDUCTION FOR HYBRID TRACK QUALITY**

By

Ahmed Lasisi, PhD  
Doctoral Researcher  
Department of Civil & Environmental Engineering  
University of Delaware

and

Nii Attoh-Okine, PhD, P.E., FASCE  
Professor, Civil & Environmental Engineering,  
Director, UD Cybersecurity Initiative  
University of Delaware

Date: October 2019

Grant Number: 69A3551747132



## **DISCLAIMER**

The contents of this report reflect the views of the authors, who are responsible for the facts and the accuracy of the information presented herein. This document is disseminated in the interest of information exchange. The report is funded, partially or entirely, by a grant from the U.S. Department of Transportation's University Transportation Centers Program. However, the U.S. Government assumes no liability for the contents or use thereof.

## ABSTRACT

Rail geometry defects constitute a major cause of accidents in the United States. Geometry related accidents are often very severe and damaging. While rail geometry-caused derailments continue to increase according to Federal Railroad Administration (FRA) safety data, track quality analysis remains effectively unchanged. The use of TQI or track quality index takes a narrow view of track assessment by focusing on quality without considering safety. The bipartite analysis of track quality and safety results into two maintenance types: routine and corrective maintenance respectively. This report shows how to create a hybrid index that combines both element of safety and geometry quality to predict only one maintenance regime based on track condition. It is an initial step towards the big picture of creating indices that will be iterated based on maintenance savings and defect probability thresholds. This study employs a linear and nonlinear dimension reduction technique that expresses the probability distribution of observations based on the similarity or dissimilarity in their embedded space whilst also maximizing the variance in data. This study found application in principal component analysis (PCA) and T-Stochastic neighbor embedding (TSNE) for separating geometry defects from higher dimensional space to lower dimensions. Results show that while both techniques effectively reduces track geometry data, PCA yields a potential defect probability threshold in spite of TSNE being a better geometry defect predictor.

**Keywords:** Hybrid Index; dimension reduction; track quality; track geometry defect

## CONTENTS

DISCLAIMER .....	ii
ABSTRACT .....	iii
TABLE OF FIGURES .....	v
LIST OF TABLES .....	vi
EXECUTIVE SUMMARY.....	1
INTRODUCTION.....	4
TRACK MAINTENANCE AND APPROACHES .....	4
FRAMEWORK FOR HYBRID INDEX DEVELOPMENT .....	5
TRACK INFORMATION AND DATA.....	6
EXPLORATORY DATA ANALYSIS.....	7
Alignment Defects and Threshold:.....	7
Surface Profile Defects before and after Tamping .....	10
Alignment Box Plots Distribution .....	10
Feature to Feature Relationships .....	10
ANALYTICAL RESULTS AND DISCUSSION.....	12
CONCLUSION .....	15
ACKNOWLEDGEMENT .....	15
REFERENCES.....	16
ACKNOWLEDGEMENT .....	17
ABOUT THE AUTHORS .....	18

## TABLE OF FIGURES

Figure 1 (a) Train accidents by primary causes, (b) financial damage (US dollars) per major accident cause (FRA, 2018).....	2
Figure 2 Track Geometry (Lasisi and Attoh-Okine, 2019).....	5
Figure 3 Hybrid index framework. ....	6
Figure 4 Alignment measurements at Inspection 60.....	8
Figure 5 (a) Profile Measurements at Inspection 58 (b) Measurements at Inspection 59. ....	9
Figure 6 Alignment Box Plot distribution. ....	10
Figure 7 Feature-to-feature relationship. ....	11
Figure 8 Feature-to-Feature Relationship. ....	12
Figure 9 (a) Principal component defects plot, (b) TSNE 2D plot. ....	13
Figure 10 (a) Relationship between probability of alignment defect and second principal component, (b) Alignment 62ft versus probability of alignment defect. ....	15

## LIST OF TABLES

Table 1 Geometry Safety Thresholds for Track Class 4.....	1
Table 2 Track Geometry Parameters from Railroad Data .....	7
Table 3 Predictor Performance for Geometry Defects .....	14

## EXECUTIVE SUMMARY

This report examines the potential of dimension reduction applications in railway track engineering. In this study, we investigate the possibility of reducing multivariate track geometry indices into a low-dimensional form without losing much information. This was examined using both linear and nonlinear dimension reduction approaches.

However, the proposed approach takes cognizance of the fact observed multidimensional data often lies in an unknown subspace of two to three dimensions (Hastie, Tibshirani and Friedman, 2009). Hence, detecting this subspace in track geometry data can significantly enable authors to eliminate redundant information. This will make it possible to visualize multidimensional track geometry data in two or three dimensions which was hitherto impossible with the raw parameters obtained from track geometry cars. The second section of this report focuses on introducing objective and artificial track quality indices. The third section considers selected machine learning methods that are used to train, test and validate the use of single and combined track quality indices including the proposed principal components. Low-dimensional representation of multivariate track geometry parameters in terms of principal components was validated and compared to existing TQIs in the penultimate section. The last section of this report discusses threshold development, highlights key findings with concluding remarks.

The current billion dollars lost annually to track geometry accidents (see Figure 1b) can be effectively diverted to rail capital improvement projects if accidents are reduced. One approach to address this problem is track quality assessment and safety practices. The apparent disjoint in two very connected entities raises a lot of questions as to the effectiveness of rail maintenance practices. If track quality indices reflect a condition assessment of rail track, how is safety completely excluded? A TQI that tells the condition of the track should exhibit inherent attributes that dictates when track is of bad quality, hence unsafe for operations. Safety thresholds are currently mandated by FRA for different track parameters and classes Table 1 shows and example of safety threshold for FRA Class 4. These thresholds can also be predetermined by railroads. Setting a threshold parameter is often nontrivial. This work attempts to illustrate an objective framework through which safety thresholds can be predetermined without losing track quality information.

**Table 1 Geometry Safety Thresholds for Track Class 4**

	Profile	Cross Level	Warp	Alignment	Maximum Super-elevation
Threshold	52	32	44	32	85

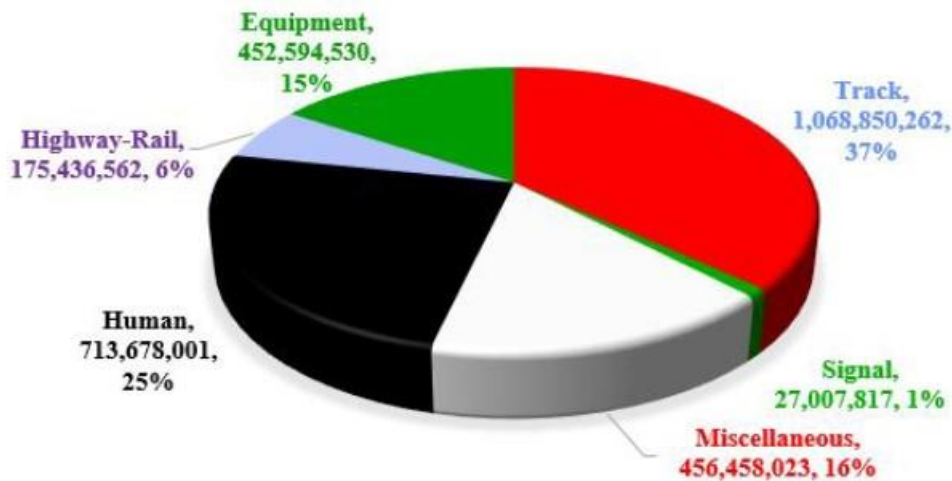
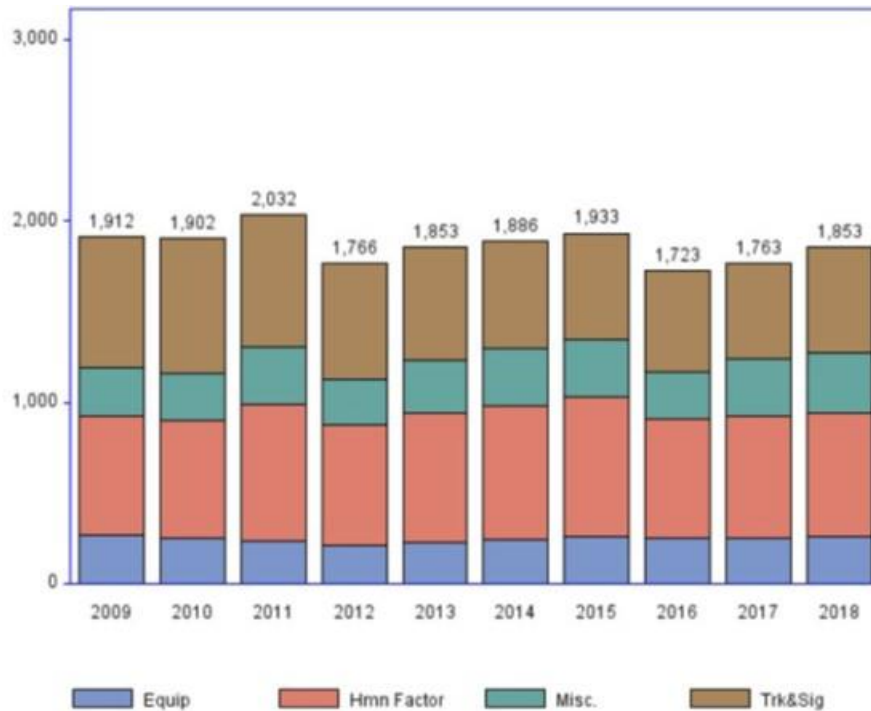

**Figure 1 (a) Train accidents by primary causes, (b) financial damage (US dollars) per major accident cause (FRA, 2018).**

To proffer a comprehensive solution, one approach would consider a technique that can combine track geometry parameters in a way that geometry sensitivities and safety thresholds are accounted for. This technique/algorithm will cater for different speeds or combination of speeds on geometry inspection cars. Study has shown that repeated multiple defects at the edge of safety limits translates into car body harmonics that is also likely to cause a train derailment as much as a safety violation (Zarembski, Attoh-Okine and Einbinder, 2015).

To account for inherent track quality based on geometry data, an objective hybrid index is necessary. This index should be capable of reflecting true track quality and "ride-ability", hence



safety. Such an index would maximize the time between maintenance cycles with little or no need for spot corrections. If this happens, track sections on the borderline of FRA safety thresholds should be easily identified with minimal false alarms. In the long run, the number of derailments per inspection miles should reduce significantly. Lastly, the index should effectively summarize multivariate track geometry data in about two or three decision parameters. While the ideal attributes of a hybrid index have been highlighted, this study attempts to address some of the enumerated features through the use of linear and non-linear dimension reduction.

## INTRODUCTION

Track Quality Index is a measure of ride quality and comfort. It is a reflection of track fitness for safe rail operations. There are two major types.

1. Objective Index: This is a type of index that is based on each of the measured parameter in Figure 3. Each parameter is originally measured in per unit length but the sensitivities per-unit length makes it difficult to make decisions for a run or stretch of track. Figure 3 describes a typical signature of raw geometry measurements. In order to avoid this hyper-sensitivities, an aggregate measure for a defined length (e.g. 200ft) of track is taken. This aggregate measure is known as objective or single track quality index.
2. Artificially-Combined Indices (ACI): Due to different track parameters and thresholds, railroads develop an approach to combine different objective TQIs to give an overall track quality measure. This combination is mostly a weighted sum of each parameter with the weights varying from one railroad to the other. One example is found in the Canadian National TQI which assumes a uniform weight for all parameters by averaging the individual TQIs for each parameter.

$$TQI_i = 1000 - C(\sigma_i^2);$$

where

$\sigma_i$ = standard deviation of each parameter,  $C$ = constant, 700 for mainline track,  $TQI_i$ = computed TQI for each parameter

An average of all six parameters except warp is given as the overall track quality:

$$ACI = \sum_{i=1}^6 \sigma_i$$

Detailed examples and application of both classes of indices have been described in (Lasisi and Attoh-Okine, 2018).

## TRACK MAINTENANCE AND APPROACHES

Rail track maintenance can be broadly classified as follows:

- Inspection-Driven Maintenance: This is also known as spot or corrective maintenance whereby inspection runs flag potentially dangerous locations on track that need to be tamped or realigned. These flags can be red or yellow. Red flags often indicate FRA violations while yellow flags indicate railroad violations [6]. The former is legally enforced while the latter is not it happens that railroads would omit red flags to avoid the legal requirement to fix it immediately or stop trains from operations. The scheduling of train inspection cycles is required to be strategic so trains do not run on a potentially dangerous section of track before

inspection. Hence, the inherent shortcomings of Inspection-Driven or spot maintenance makes it not cost and time effective.

- **Routine Maintenance:** Routine maintenance as the name indicates is not necessarily a condition-based maintenance. Tampers, stone-blowers and other track equipment are scheduled for track work at pre-determined intervals or cycles irrespective of track quality, tonnage or condition.

The obvious pitfalls here are: (1) Potential safety misses, (2) Ineffective and inefficient resource utilization, (3) Recurring track-geometry accidents, and (4) Lack of flexibility and adaptation to changing needs

- **Data-Driven Maintenance:** This maintenance approach on the other hand takes advantage of data analytical methods to forecast track geometry parameters' safety exceedance. It employs several mathematical, optimization and programming techniques to maximize time and cost. Once a safety threshold is anticipated, maintenance can therefore be scheduled depending on the risk attitude of decision makers (Galván-Núñez and Attoh-Okine, 2018).

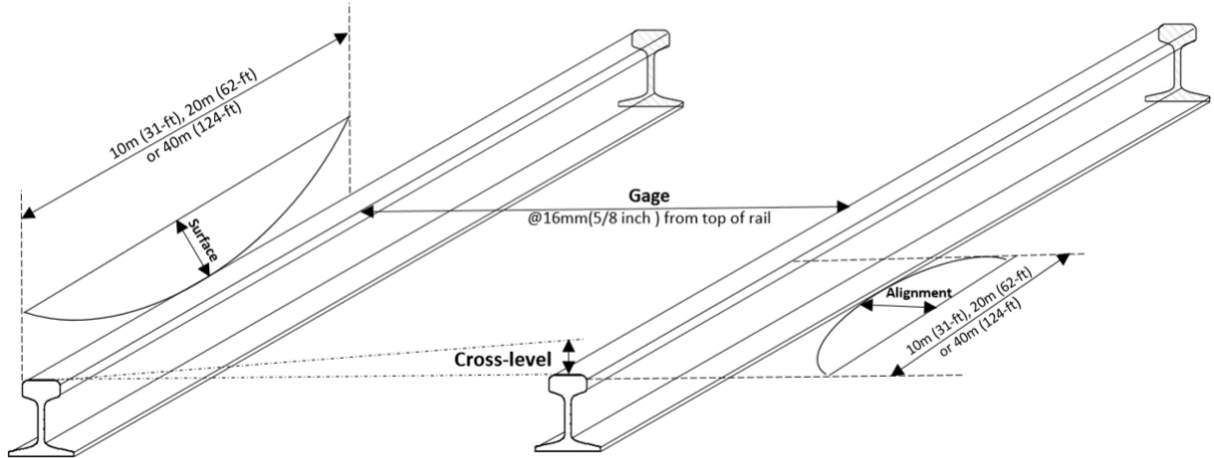

**Figure 2 Track Geometry (Lasisi and Attoh-Okine, 2019).**

## FRAMEWORK FOR HYBRID INDEX DEVELOPMENT

In this section, we describe the high level framework in which the described dimension reduction techniques will be applied. Figure 3 presents a process through which multivariate track geometry data can be churned to create artificial measured track performance to save maintenance cost and minimize track operations disturbance. This process starts with an unsupervised learning technique using PCA and TSNE as dimension reduction techniques as already described. The reduced dimensions are then tested through a structured validation process on track geometry data. After testing the geometry-defect predicting power of these components, the output is converted to defect probabilities using a soft-max or logit function (Charniak, 2018).

These probabilities are then assessed for each parameter and original track geometry values as a test of true quality reflection. Setting the probability threshold for each track parameter is non-trivial. Authors propose an iterative process that adjusts the probability thresholds based on the

cost and time savings on maintenance until an optimum value is asymptotically observed. The probability thresholds may be different for each track and therefore requires a careful tuning. The focus of this study is mostly on the combination of unsupervised and supervised learning sections of the framework as well as probability conversion and assessment. The probability tuning is excluded to be featured in a future work.

In the following sections, authors describe a case study with track geometry data implemented based on the described approach.

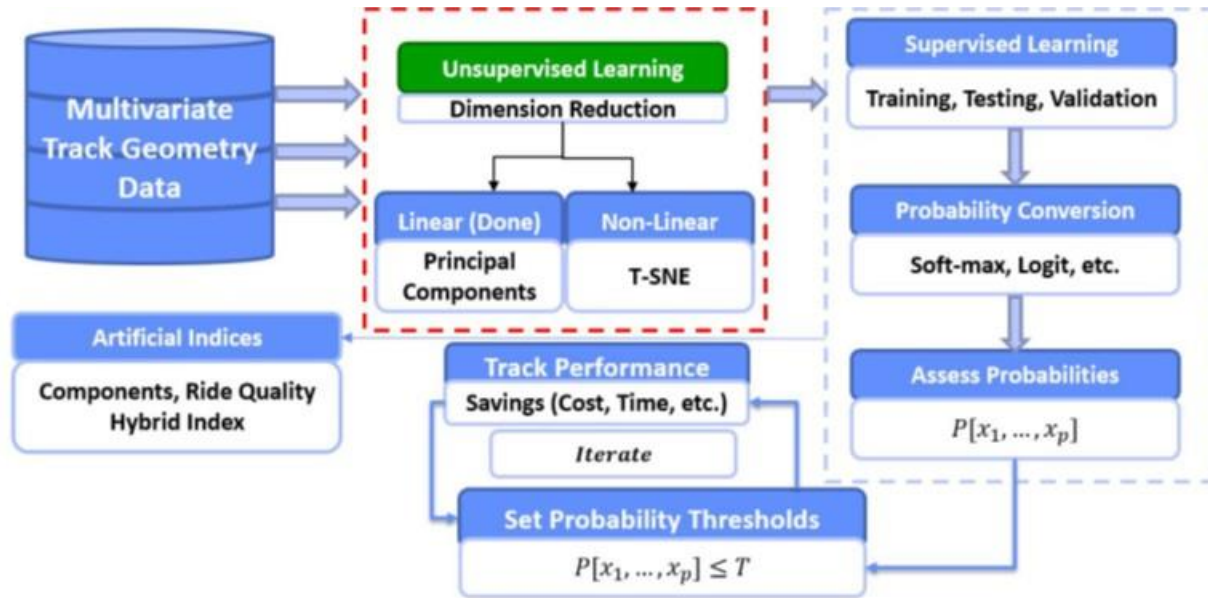

**Figure 3 Hybrid index framework.**

## TRACK INFORMATION AND DATA

A brief illustration of the data is given below:

- One year of track inspection data.
- 10 years of general maintenance data.
- Approximately five years of annual tonnage data
- Over 82 kilometers of track inspection data.
- 5 segment of double line track.
- 0.3% defects per overall inspection data.

Data was collected from a double Class 4 South American Railroad. The safety thresholds for the track (FRA Track Class 4) is given in Table 2.

**Table 2 Track Geometry Parameters from Railroad Data**

<b>Selected Track Geometry Parameters</b>	
<b>Parameter</b>	<b>Description</b>
KM	Milepost: Kilometer
Feet	Fraction of KM
Super	Super elevation of track
Profile10m_R	Right 10m (31ft) wavelength of profile
Profile20m_R	Right 20m (62ft) wavelength of profile
Profile10m_L	Left 10m (31ft) wavelength of profile
Profile20m_L	Left 20m (62ft) wavelength of profile
Alignment10m_R	Right 10m (31ft) wavelength of alignment
Alignment20m_R	Right 20m (62ft) wavelength of alignment
Alignment10m_L	Left 10m (31ft) wavelength of alignment
Alignment20m_L	Left 20m (62ft) wavelength of alignment
Unloaded_Gage	Unloaded Gage
RCANT	Right Cant
LCANT	Left Cant
DEFECTS	Multi-class geometry defect label based on data
MP	Continuous Computed Milepost from KM and Feet Fields

There are several parameters collection from the field, 11 of these parameters have been selected relevant for this study. These parameters include: (1) unloaded gage, (2) left cant, (3) profile right (62ft), (4) profile right (31ft), (5) profile left (62ft), (6) profile left (31ft), (7) alignment right (62ft), (8) alignment right (31ft), (9) alignment left (62ft), (10) alignment left (31ft). (11) super elevation, and (12) right cant.

## **EXPLORATORY DATA ANALYSIS**

For this study, the data was explored through the following perspectives:

### **Alignment Defects and Threshold:**

Figure 4 shows the alignment behavior at Inspection run 60 right before the inspection discussed in Figure 3. Figure 4 highlights few alignment defects but very high magnitudes (75mm) around KM 106.3. After tamping, Figure 3 shows that there are still alignment defects of lower magnitudes in the same location. While it is easy to conclude that the tamping between the two inspections was not effective, inspection data showed that there was up to 4 months between both inspections which makes it possible for the tamping to have been done immediately after inspection 60. The use of tamping as a corrective measure for track irregularity remains controversial because studies have shown that tamping increases the rate of deterioration (Nielsen *et al.*, 2018).

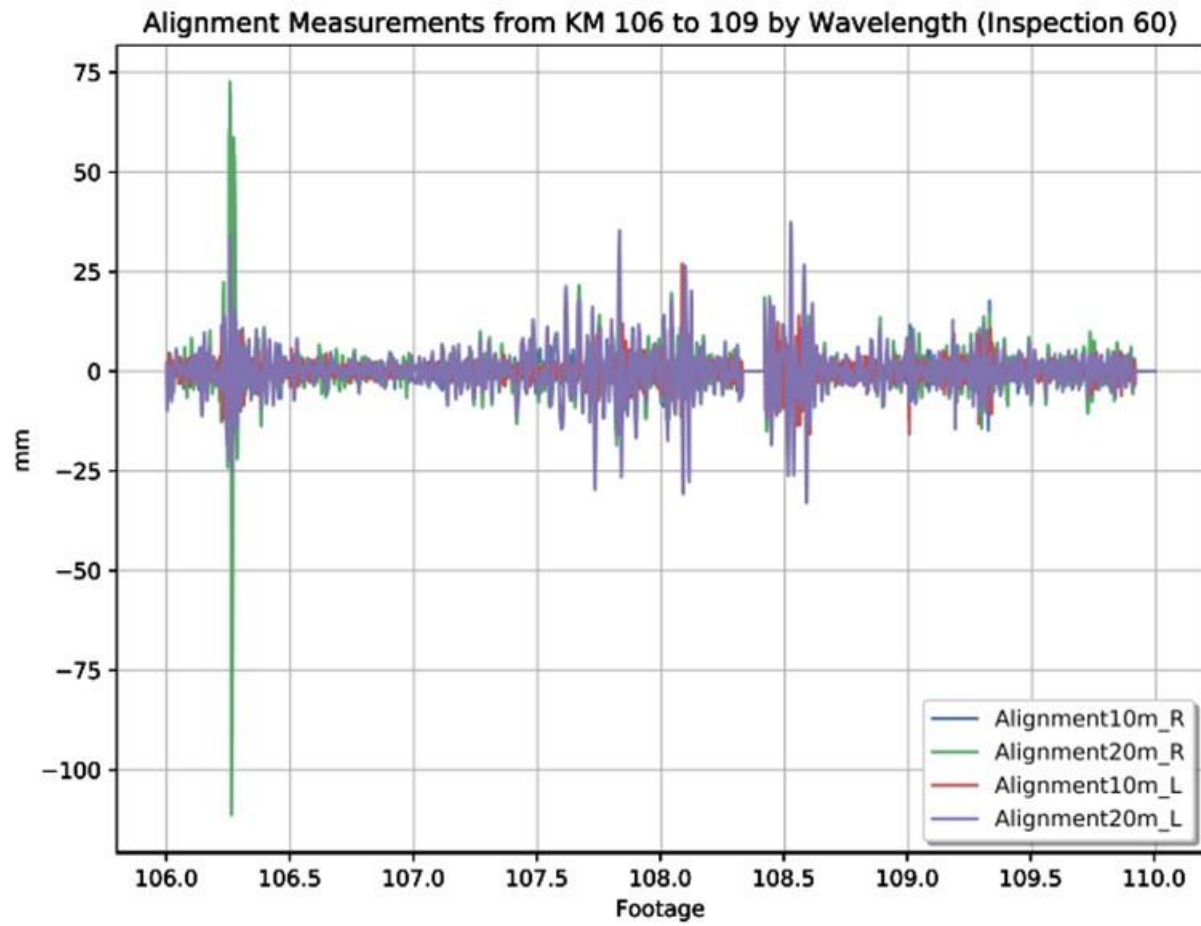

**Figure 4 Alignment measurements at Inspection 60.**

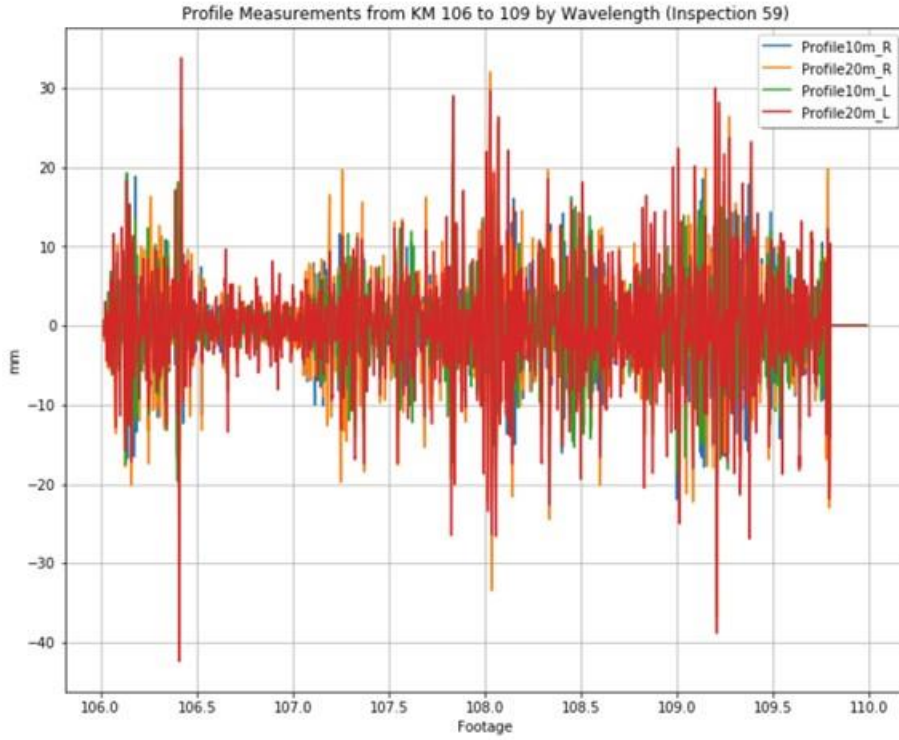

(a)

Profile Measurements from KM 106 to 109 by Wavelength (Inspection 58)

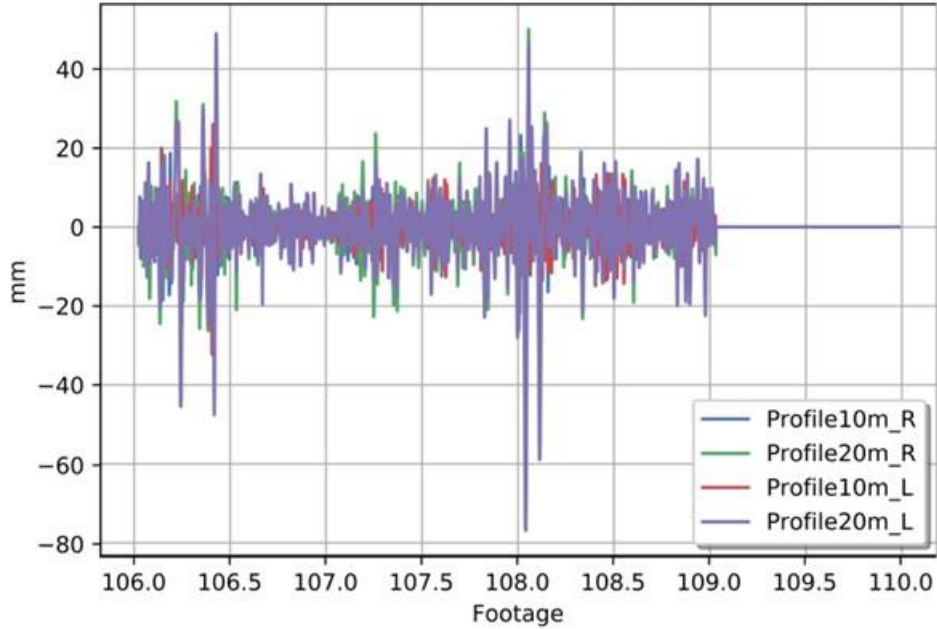

Figure 5 (a) Profile Measurements at Inspection 58 (b) Measurements at Inspection 59.

(b)

## Surface Profile Defects before and after Tamping

It can be observed from Figure 5 that profile deviations generally reduced after tamping. Recall that the threshold for Profile is 51mm (62ft) (See Table 1). Therefore, several profile defects are observable from KM 106.5 and KM 108.0. These defects were completely eliminated at Inspection 59 as obvious from Figure 6b. Maintenance data shows that there was a tamping activity from KM 102 to 109 between the two maintenance cycles. In terms of safety, it can be argued that many of the defects were eliminated despite continuous train operations but the nature of ride quality remains a subject of investigation.

## Alignment Box Plots Distribution

While the descriptive statistics for surface profile has been presented earlier, Figure 6 presents the variability in different alignment wavelengths after tamping. It is expected that shorter wavelengths should vary less than longer wavelengths but this is not the case for Alignment10m\_L. This finding challenges the rationale behind FRA safety thresholds that specify higher limits for higher parameter wavelength (FRA, 2002) & (Lee, 2005).

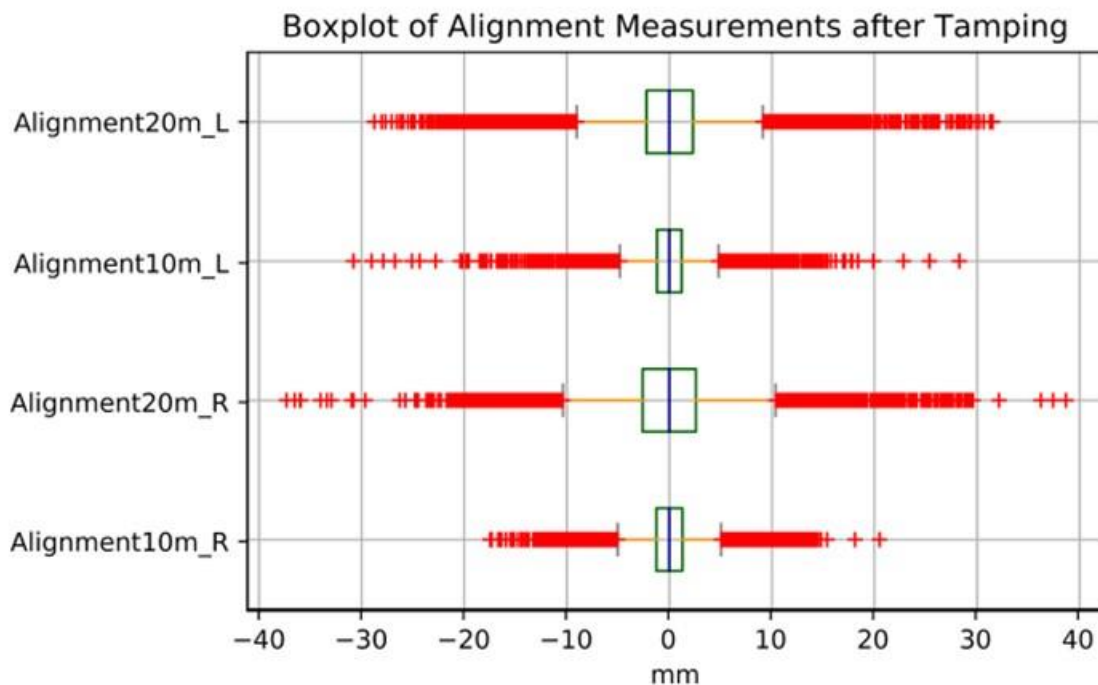

**Figure 6 Alignment Box Plot distribution.**

## Feature to Feature Relationships

Several studies have tried to characterize the inter-correlations within track geometry parameters or even rail defects (Zarembski, Attoh-Okine and Einbinder, 2015), (Mohammadi *et al.*, 2019),



(Soleimanmeigouni, Ahmadi and Kumar, 2018), (Zarembski, Einbinder and Attoh-Okine, 2016). Firstly, one relationship is to investigate how parameters interact across board while it is also possible to look at the relationships between wavelengths and side of rail (R or L). Figure 7 shows strong correlations between measurements on the left and right sides of rail. This explains why certain TQIs average both parameters or simply use either of them (Sharma *et al.*, 2018). The next strongest correlations are between different wavelengths of the same parameter on the same side of rail (e.g. Alignment10m\_R and Alignment20m\_R). The correlations measurements of opposing rail sides and different wavelengths of the same parameter (e.g. Profile10m\_L and Profile20m\_R) are generally about 0.4. Aside this, the correlations of different parameters are generally very low except for Gage and Cant. With this information, the nature of track geometry data is properly understood before attempting dimension reduction with PCA and TSNE to predict track geometry defects.

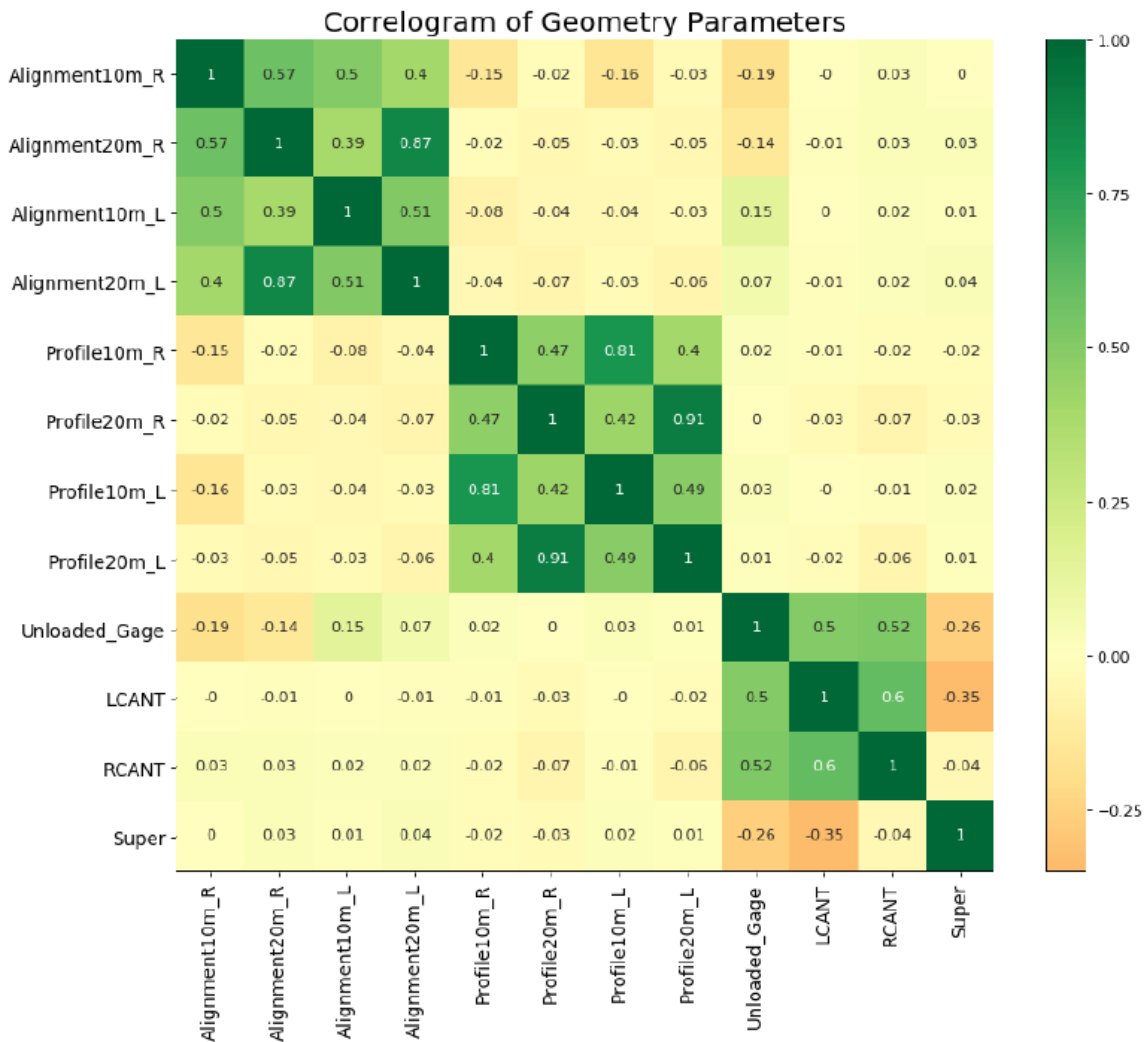

**Figure 7 Feature-to-feature relationship.**

## ANALYTICAL RESULTS AND DISCUSSION

In this section, we look at the analytical results of the dimension reduction and subsequent analysis proposed earlier. For principal components to effectively summarize data, the percentage variance explained versus the number of components or scree plot should be examined. Figure 8 shows that the first principal component explains over 85% of the variance and the first three, about 95%. Thus, it can be concluded that principal components are well suited for track geometry data. In order to visually interact with geometry defects, data from inspection 58, 59 and 60 were stacked and the reduced components are plotted in Figure 10. The thresholds in Table 1 have been applied to label the measurements with defect and plot them as indicated. The principal components do a good job of showing the scores for profile and alignment defect which is otherwise masked in the TSNE plots.

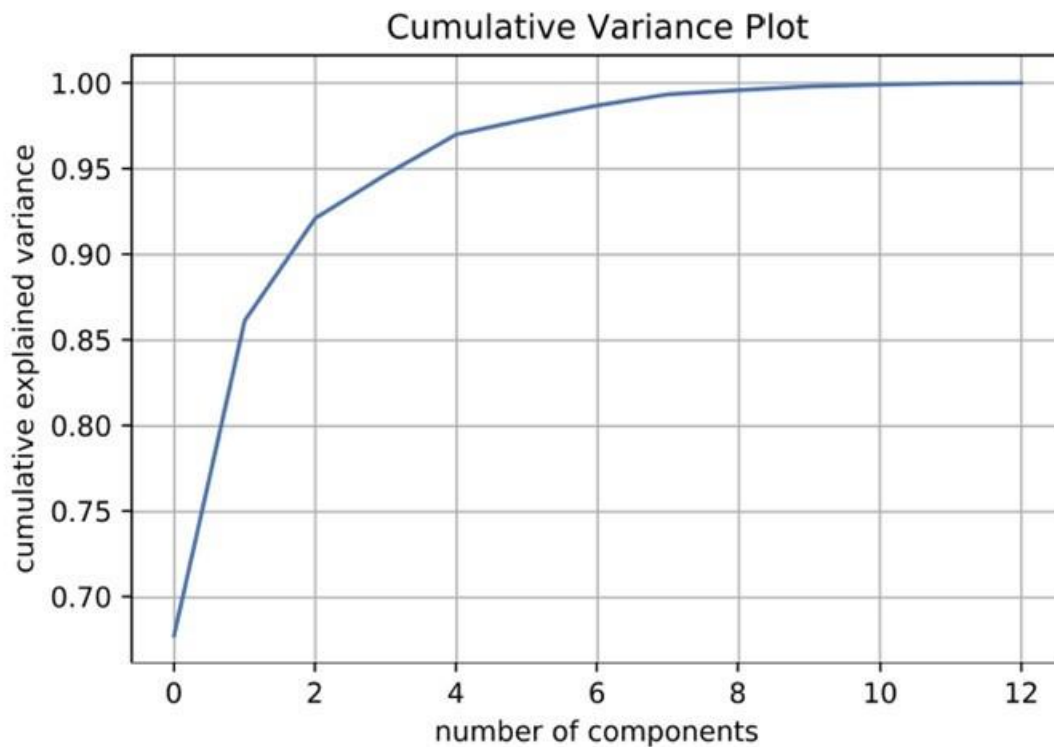

**Figure 8 Feature-to-Feature Relationship.**

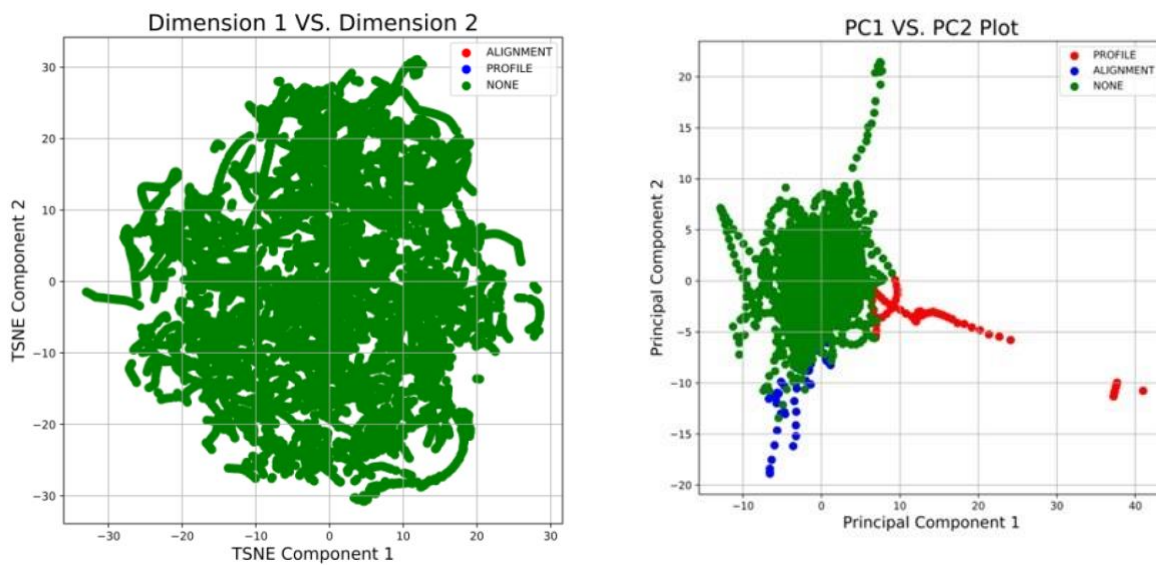

**Figure 9 (a) Principal component defects plot, (b) TSNE 2D plot.**

Based on the information presented in Figure 9, it is possible to set a principal component threshold for profile defects as 5 for the first principal component. Every inspection can be monitored to avoid this limit. Same can also be implemented for the alignment with a PC2 value of -5. The prediction performance of the components has been described in Table 3. The prediction defects were conducted for a highly unbalanced data set with the target defect column having unique values as follows: [Alignment, Profile, None]. The predictors were changed for each training. Raw track geometry data (Table 2), three (3) principal components and 3D TSNE components were used as predictors during each training. A multi-layer perceptron neural network model implemented in (Pedregosa *et al.*, 2011) was employed. The results show that TSNE generally has the better prediction performance after the raw geometry data. But the inability to visually separate the defects for threshold development is a subject of ongoing research. This will enable a visual correlation with defect probabilities that can be effectively communicated to a railroad audience. Due to the inability of TSNE to visually separate geometry defects from non-defect observations, authors have only focused on the relationship between principal components and probability of defect. In order, to obtain the probability of defect, a soft max function was employed according to the framework described in Figure 3.

Firstly, the defects considered from Inspection 58, 59 and 60 were extracted and the probability, computed. Fig 11a presents the probability of alignment defects versus the second principal component. While these probabilities vary widely for the three Inspection data selected, the probability for a given location does not vary the same way (Figure 11b). In order words, a probability of 0.5 does not always mean average likelihood of defect. Therefore, it is pertinent to critically study these probabilities before creating thresholds.

**Table 3 Predictor Performance for Geometry Defects**

<b>Profile</b>			
<b>Predictor</b>	<b>TPR</b>	<b>FPR</b>	<b>Accuracy</b>
Raw Track Geometry Data	0.95364	0.02913	0.99798
3 Principal Components	0.93892	0.13297	0.97867
3D-TSNE Components	0.94801	0.08834	0.98230
<b>Alignment</b>			
Raw Track Geometry Data	0.92651	0.17869	0.96543
3 Principal Components	0.98672	0.24354	0.98907
3D-TSNE Components	0.96743	0.15462	0.95679
<b>No Defect</b>			
Raw Track Geometry Data	0.99963	0.16752	0.99949
3 Principal Components	0.92448	0.00026	0.99770
3D-TSNE Components	0.99984	0.93589	0.99461

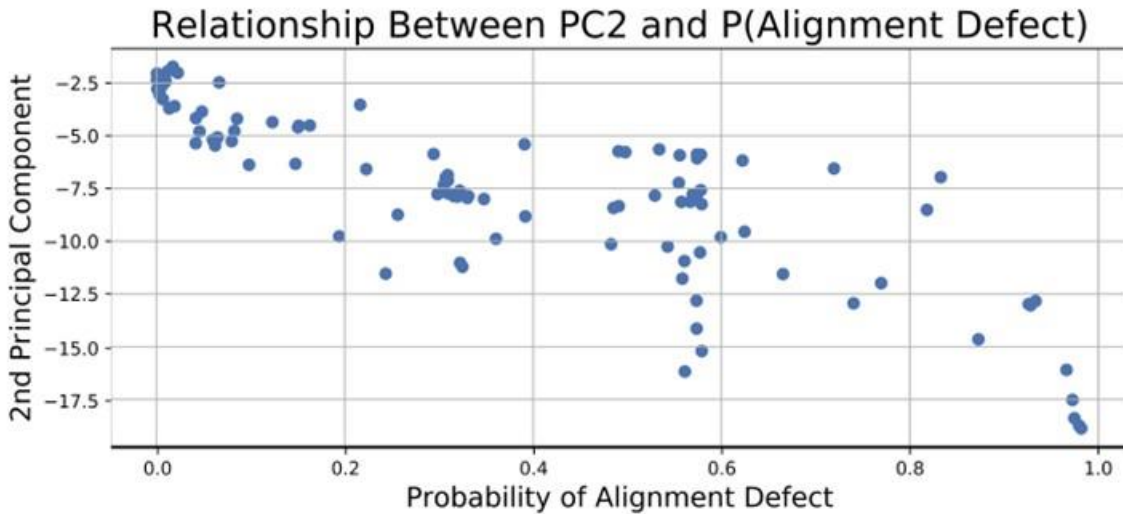

(a)

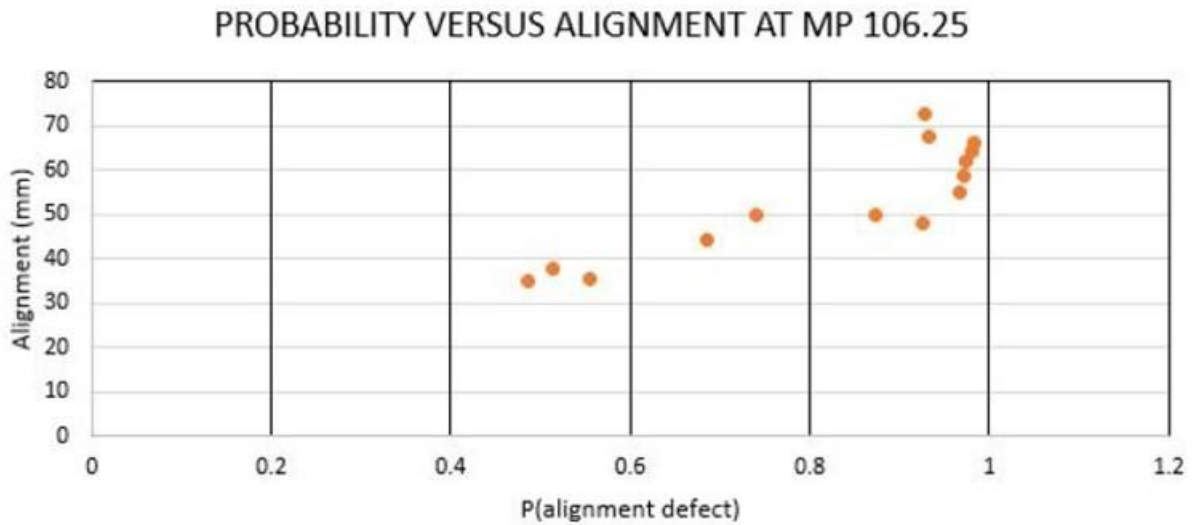

(b)

**Figure 10 (a) Relationship between probability of alignment defect and second principal component, (b) Alignment 62ft versus probability of alignment defect.**

## CONCLUSION

In this work, some of the shortcomings of the bipartite geometry safety defect and track quality index were addressed. This study examines the potential to create a hybrid index using linear and nonlinear dimension reduction was explored. Results show that TSNE is well suited for geometry defect prediction while PCA offers a first step to creating defect probability thresholds corroborated by a visual separation of defects in the components scores' plot. The 3D decomposition of track geometry data was again verified using data from a Track Class 4 Railroad. Future work will consider the risks associated with each defect and quantify the corresponding severity to be used a maintenance decision-making tool which can be iterated based on the risk attitudes of infrastructure managers.

## ACKNOWLEDGEMENT

Special thanks to the following parties for the continuous support throughout this research effort:

- University of Delaware, Department of Civil Engineering
- RailTEAM, USDOT Tier 1 University Transportation Center on Railroad Infrastructure Sustainability and Mobility
- Federal Transit Administration
- United States Department of Transportation
- Malha Sudeste Logistica Brazil

## REFERENCES

1. Charniak, E. (2018) *Introduction to Deep Learning*. 1st edn. Cambridge, Massachusetts: The MIT Press.
2. FRA (2002) ‘Track Safety Standards Compliance Manual’, *Track and Rail and Infrastructure Integrity Compliance Manual*, 4.
3. FRA (2018) 3.11 - *Accident Detail Report*, *Federal Railroad Administration Office of safety Analysis*. Available at: <https://safetydata.fra.dot.gov/OfficeofSafety/publicsite/Query/incrpt.aspx> (Accessed: 18 February 2019).
4. Galván-Núñez, S. and Attoh-Okine, N. (2018) ‘A threshold-regression model for track geometry degradation’, *Proceedings of the Institution of Mechanical Engineers, Part F: Journal of Rail and Rapid Transit*, 232(10), pp. 2456–2465. doi: 10.1177/0954409718777834.
5. Hastie, T., Tibshirani, R. and Friedman, J. (2009) *The Elements of Statistical Learning, Springer Series in Statistics*. Springer Texts in Statistics. doi: 10.1007/b94608.
6. Lasisi, A. and Attoh-Okine, N. (2018) ‘Principal components analysis and track quality index: A machine learning approach’, *Transportation Research Part C: Emerging Technologies*. Elsevier, 91(April), pp. 230–248. doi: 10.1016/J.TRC.2018.04.001.
7. Lasisi, A. and Attoh-Okine, N. (2019) ‘Machine Learning Ensembles and Rail Defects Prediction: A Multi-Layer Stacking Methodology’, *ASCE-ASME Journal of Risk and Uncertainty in Engineering Systems, Part A: Civil Engineering*.
8. Lee, S. (2005) *Development of Objective Track Quality Indices*, *US Department of transportation Federal Railroad Administration Research Results*.
9. Mohammadi, R. *et al.* (2019) ‘Exploring the impact of foot-by-foot track geometry on the occurrence of rail defects’, *Transportation Research Part C: Emerging Technologies*. Pergamon, 102, pp. 153–172. doi: 10.1016/J.TRC.2019.03.004.
10. Nielsen, J. *et al.* (2018) ‘Degradation of railway track geometry – Correlation between track stiffness gradient and differential settlement’, *Proceedings of the Institution of Mechanical Engineers, Part F: Journal of Rail and Rapid Transit*. SAGE PublicationsSage UK: London, England, p. 095440971881958. doi: 10.1177/0954409718819581.
11. Pedregosa, F. *et al.* (2011) ‘Scikit-learn: Machine Learning in Python’, *Journal of Machine Learning Research*, 12, pp. 2825–2830. Available at: [https://scikit-learn.org/stable/modules/generated/sklearn.model\\_selection.GridSearchCV.html](https://scikit-learn.org/stable/modules/generated/sklearn.model_selection.GridSearchCV.html).
12. Sharma, S. *et al.* (2018) ‘Data-driven optimization of railway maintenance for track geometry’, *Transportation Research Board Part C*. doi: 10.1016/j.trc.2018.02.019.
13. Soleimanmeigouni, I., Ahmadi, A. and Kumar, U. (2018) ‘Track geometry degradation and maintenance modelling: A review’, *Proceedings of the Institution of Mechanical Engineers, Part F: Journal of Rail and Rapid Transit*. SAGE PublicationsSage UK: London, England, 232(1), pp. 73–102. doi: 10.1177/0954409716657849.
14. Zarembski, A., Attoh-Okine, N. and Einbinder, D. (2015) ‘On the Relationship between Track Geometry Defects and Development of Internal Rail Defects’, pp. 1–7.
15. Zarembski, A. M., Einbinder, D. and Attoh-Okine, N. (2016) ‘Using multiple adaptive regression to address the impact of track geometry on development of rail defects’, *Construction and Building Materials*, 127, pp. 546–555. doi: 10.1016/j.conbuildmat.2016.10.012.

## **ACKNOWLEDGEMENT**

This study was conducted with the support from the USDOT Tier 1 University Transportation Center on Railroad Sustainability and Durability.

## ABOUT THE AUTHORS

### **Ahmed Lasisi**

Mr. Lasisi was a Research Assistant and Doctoral Candidate in the Railroad Program at the University of Delaware when this study was conducted. While he studied for his Ph.D. degree, his research interests include: Track Quality Safety, Spatial Analytics and Machine Learning Optimization, Transportation Infrastructure Improvements using multidisciplinary data analytical methods. Data-Driven Risk Analysis and Simulation Engineering. He obtained his Ph.D. in civil engineering from the University of Delaware, his Masters' and BS degrees from the University of Lagos of Nigeria in civil engineering.

### **Nii O. Attoh-Okine, Ph.D., P.E., F. ASCE, Snr Member IEEE**

Nii O. Attoh-Okine, Professor of Civil and Environmental Engineering, and Electrical and Computer Engineering. He is also the Interim Academic Director of the University of Delaware Cybersecurity Initiative. In the last couple of years, he has authored two books which are defining the direction of research across disciplines: a) Resilience Engineering: Models and Analysis and b) Big Data and Differential Privacy in Railway Track Engineering. He is a founding associate editor for ASCE/ASME Journal of Risk and Uncertainty Analysis. He has served as an Associate Editor on the four ASCE Journals. Attoh-Okine is currently a member of a group of researchers from the United States and Japan working on Smart Cities and various cyber issues related to the Tokyo 2020 Olympic Games.