

Department of  
Mathematical Sciences  
Faculty Research Areas

# Statistical genetics and biostatistics

Dr. Amei Amei

Professor,

Department of Mathematical Sciences

Email: [amei.amei@unlv.edu](mailto:amei.amei@unlv.edu)

## Expertise

- Statistical methods to detect risk genes and gene-environment interactions underlying complex diseases
- Large-scale sequence-based genetic association studies
- Statistical inference of stochastic modeling
- Bayesian variable selection

# Genome-wide association studies in hypertension and schizophrenia

- In genome-wide association analysis of longitudinal traits, modeling time-varying genetic effect can increase power for the detection of genes underlying the development and progression of complex diseases.
- BVS methods can be used to reanalyze published datasets to discover new risk genetic variants for many diseases without new sample collection, ascertainment, and genotyping.

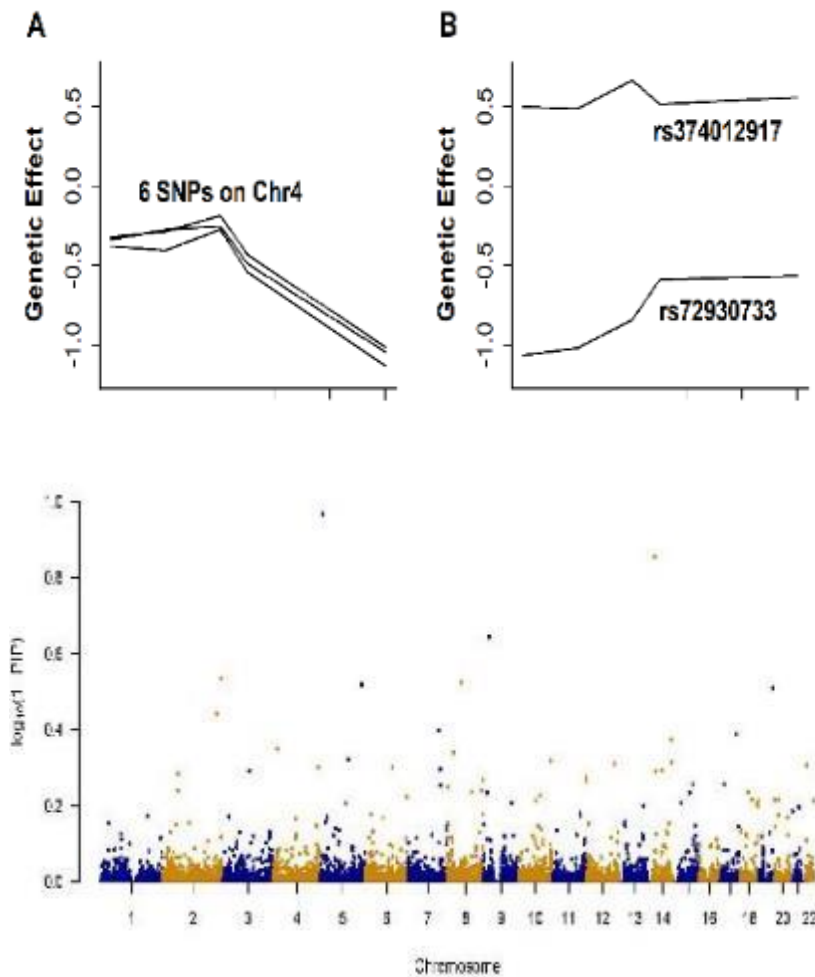

# Gennady Bachman

- Professor, Department of Mathematical Sciences
- Ph.D., University of Illinois at Urbana-Champaign
- CDC 908, [Gennady.Bachman@unlv.edu](mailto:Gennady.Bachman@unlv.edu)



## **Area of Expertise:** Number Theory

Number theory is a branch of mathematics that is widely concerned with properties of integers. This field is largely driven by intellectual curiosity and enjoys an unparalleled wealth of great challenges. Certain aspects of number theory have also become foundational for an increasingly important and growing set of practical applications, largely through our increasing reliance on computing.

My recent research is focused on getting a better understanding of a certain number theoretic process. While seemingly simple and transparent, somehow it manages to generate interesting and rich structures, and even some basic fundamental questions remain open.

# Hokwon A. Cho

- Associate Professor of Statistics, Department of Mathematical Sciences
- Ph.D., Statistics & Applied Probability, University of California, Santa Barbara
- Office: CDC 1008, Hokwon.Cho@unlv.edu
- Web page: <http://cho.faculty.unlv.edu>

## Areas of Expertise

- Statistical Decision Theory
  - Sequential Analysis and Sampling Theory
  - Selection & Ranking and Multiple Comparisons
- Linear Models
- Non-parametric methods

## Research Summary:

My research interests are mainly in statistical decision theory. More specifically speaking, focus on developing estimating methods and theory on sequential methods and multiple decision problems.

Recent papers submitted for publications are on estimating ratio of two binomial population parameters using sequential sampling and two-stage procedures. I am currently working on applications for selection-&-ranking methods.



Bookplate at Lied Library - UNLV Author Celebration

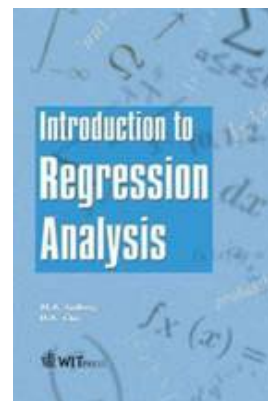

First Ed. (2004)

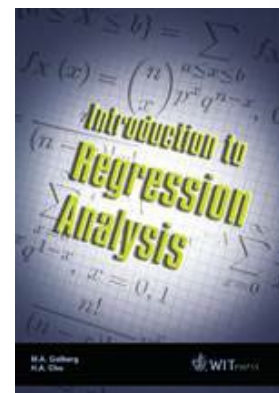

Revised &  
Updated Ed. (2010)

# Combinatorial algebraic geometry

- **Dr. Daniel Corey**
- Assistant Professor
- Department of Mathematical Sciences
- Email: [daniel.corey@unlv.edu](mailto:daniel.corey@unlv.edu)
- Website: <https://www.danieljcorey.com/>

## Expertise

- Tropical geometry
- Grassmannians and flag varieties
- Matroids, graphs, and polyhedral complexes
- Software: OSCAR (julia), polymake, Macaulay2

# Tropical geometry: combinatorics of degenerating algebraic varieties

Tropical geometry is a relatively new field that lies at the intersection of various seemingly distant areas of mathematics and computer science, like auction and game theory, optimization, machine learning, graphs, matroids, polyhedral complexes, and algebraic geometry. Within algebraic geometry, tropical geometry is the study of degenerating algebraic varieties. The degenerated object should have a purely combinatorial description, and as a result one may transform a geometric problem into a combinatorial one. Below are examples of combinatorial objects that arise in my research. Left to right, these are: a lattice path (used to enumerate curves in toric surfaces), vanishing cycles of a stable degeneration of Riemann surfaces (used to study the Ceresa cycle of a curve) and a matroid (used to study compactifications of the moduli space of lines in the projective plane in general position).

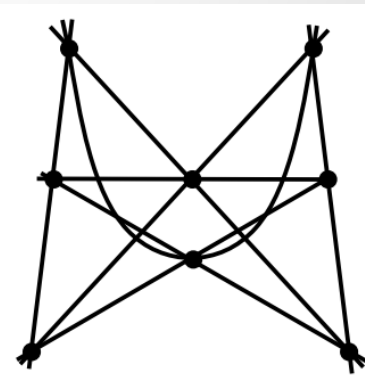
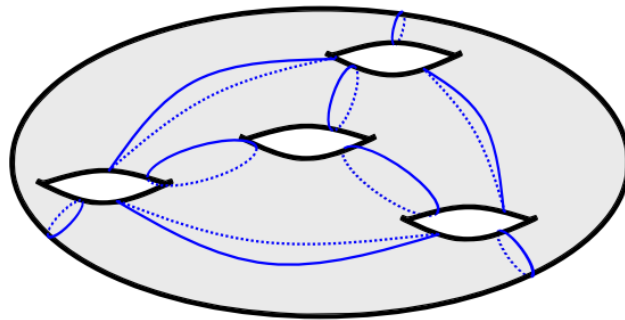
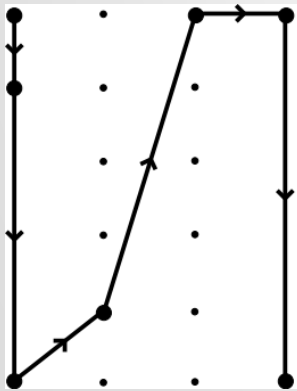

# Zhonghai Ding

- Professor of Mathematics  
Department of Mathematical Sciences
- Ph.D. in Mathematics  
Texas A&M University, College Station, Texas
- CDC 1004, Zhonghai.Ding@unlv.edu
- <https://faculty.unlv.edu/zding/>



## Areas of Expertise

- Control Theory
- Partial Differential Equation
- Mathematical Modeling
- Numerical Computation

## Research Summary:

Dr. Ding's research interests are in mathematical modeling and analysis, control, and computation of problems arising from real applications such as nematic liquid crystals, suspension bridge systems, shape memory alloys, oxidation of metal matrix composites, control of dynamical systems, etc.. These systems are governed by linear or nonlinear partial differential equations. Dr. Ding's research focus on analyzing system behaviors, developing numerical methods for solutions, and investigating related control issues.

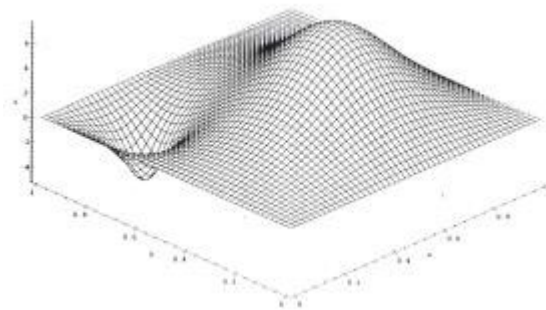
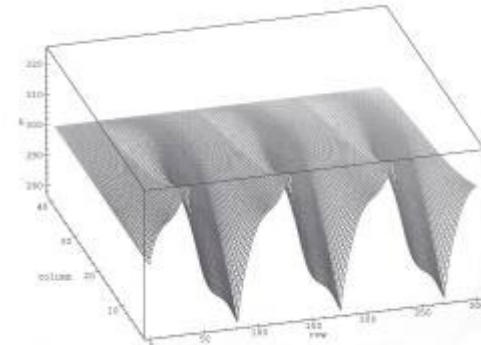



# Scientific Computing and Mathematical Modeling

- **Dr. Jichun Li**
- Full Professor
- Department Mathematical Sciences
- Email: [jichun.li@unlv.edu](mailto:jichun.li@unlv.edu)
- Website: <http://faculty.unlv.edu/jichun/>

## Expertise

- Computational Electromagnetics: wave propagation in metamaterials, graphene, and other complex media.
- Develop, analyze, and implement various numerical methods for solving various Differential Equations (DEs) in sciences and engineering.
- Machine Learning; Math finance; Numerical Analysis.

# Published over 2 books, and over 140 SCI papers

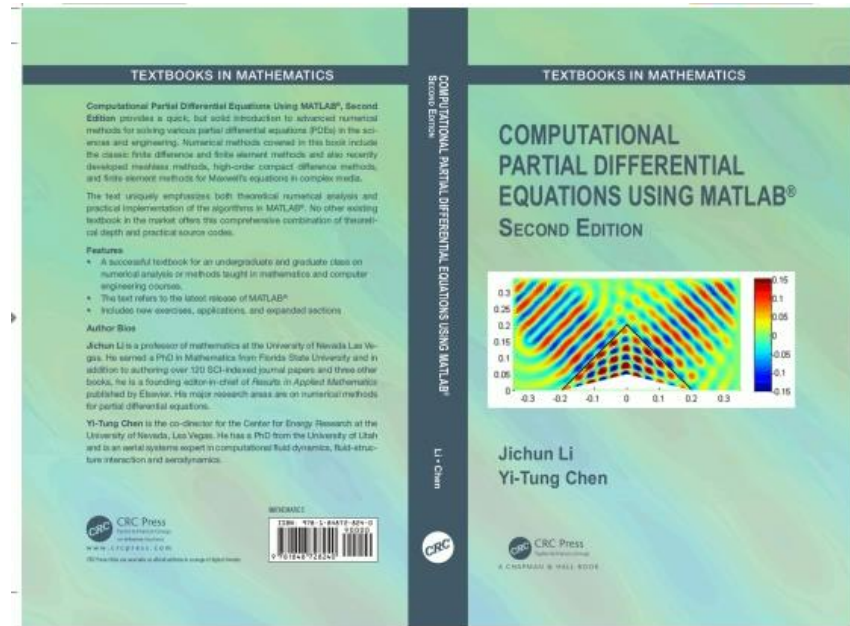
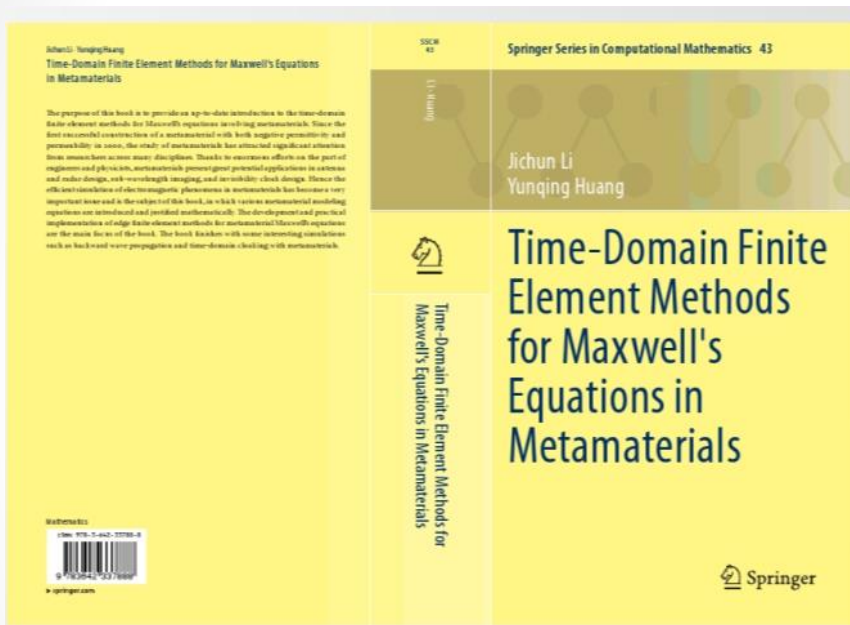

In 2023, ranked #1097 (out of total 1138) in United States and #2638 in the world in The 2nd edition of Research.com ranking of the best scholars in the arena of Mathematics: <https://research.com/scientists-rankings/mathematics/>

# Computational Fluid Dynamics

- **Dr. Monika Neda**
- Professor, Department of Mathematical Sciences
- [monika.neda@unlv.edu](mailto:monika.neda@unlv.edu)
- <https://faculty.unlv.edu/neda/>



## Expertise

- Computational Fluid Dynamics
- Turbulence
- Numerical Methods for Partial Differential Equations
- Applied Sensitivity Analysis
- STEM education

# Simulation of fluid flow: Calculations of drag and lift

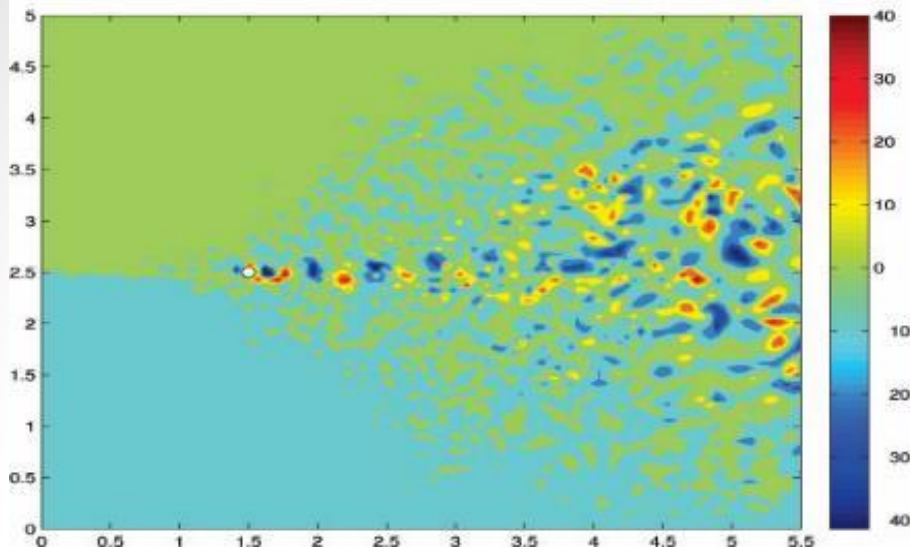

The figure (left side) presents the creation of the vortex street behind an immersed body in a fluid. It can be used to compute drag and lift in aerodynamics, such as drag and lift of aircrafts.

Simulation of fluid flow:  
Creation of eddies/vortices  
behind the step

The figure (right side)  
depicts the creation of the  
rotational structures  
behind the step as a result  
of the interaction of the  
fluid with boundaries.

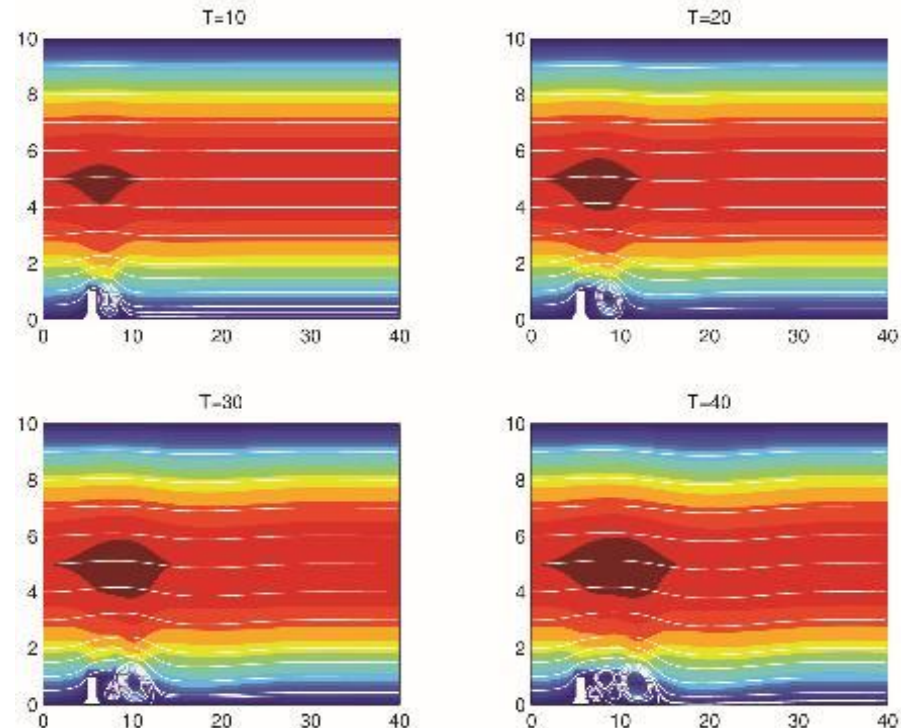

# Applied Mathematics, Biomath and Partial Differential Equations

- **Dr. Rachidi B. Salako**
- Assistant Professor of Mathematics
- Department of Mathematical Sciences
- Email: [rachidi.salako@unlv.edu](mailto:rachidi.salako@unlv.edu)
- Website: <https://rachidisalako.faculty.unlv.edu/research/>



**Expertise.** My research interests encompass Partial Differential Equations, Dynamical Systems, and Mathematical Biology. Recently, my work has concentrated on the following topics:

- Dynamics of solutions of stage-structured population models
- Analysis of infectious disease epidemic models
- Persistence and extinction in degenerate diffusion competition systems in heterogeneous environments
- Front propagation phenomena in chemotaxis models
- Spatial spreading dynamics in random media

# High-dimensional Data Analysis

- **Dr. Farhad Shokoohi**
- Assistant Professor of Statistics
- Department of Mathematical Sciences
- Email: [farhad.shokoohi@unlv.edu](mailto:farhad.shokoohi@unlv.edu)
- Website: <https://farhad.faculty.unlv.edu>



## Expertise

- Bayesian and Frequentist Analysis
- Mixture Modelling
- Survival Analysis
- High-Dimensional Genomics and Epigenetic
- Sparse Estimation in Finite Mixture of Regressions
- Machine Learning in Medical and Financial Data
- Differential DNA Methylation Analysis in Cancer Epigenetics
- Hidden Markov Models
- Nonparametric and Semiparametric Regression
- Software Development



# High-dimensional data analysis across a variety of sectors, including finance, healthcare, genomics, market, among others.

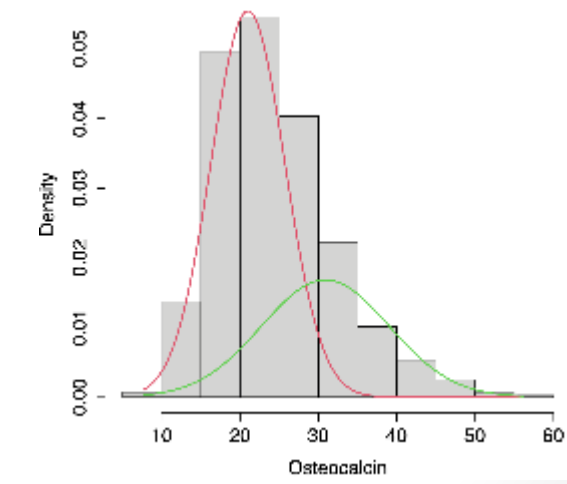
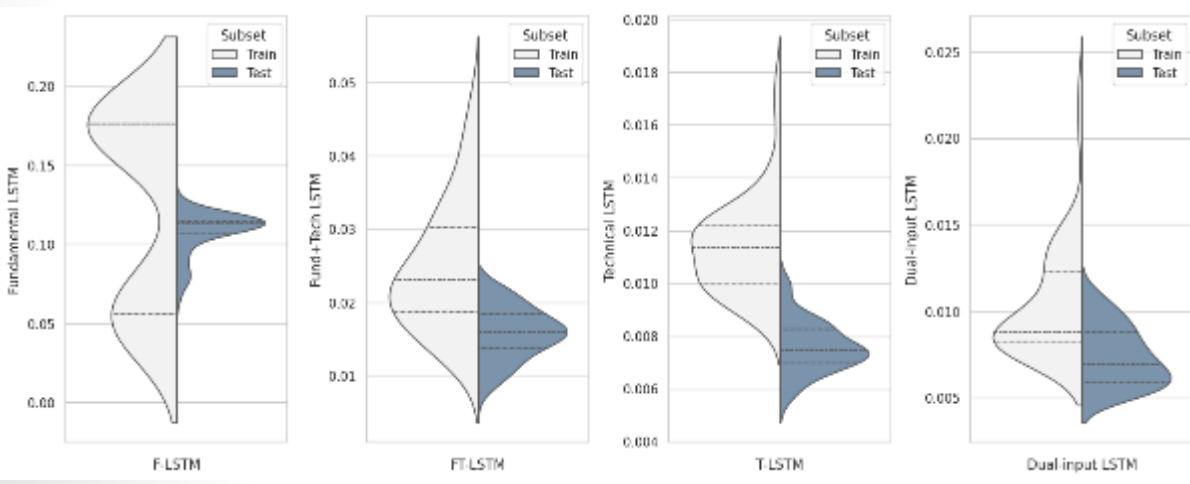
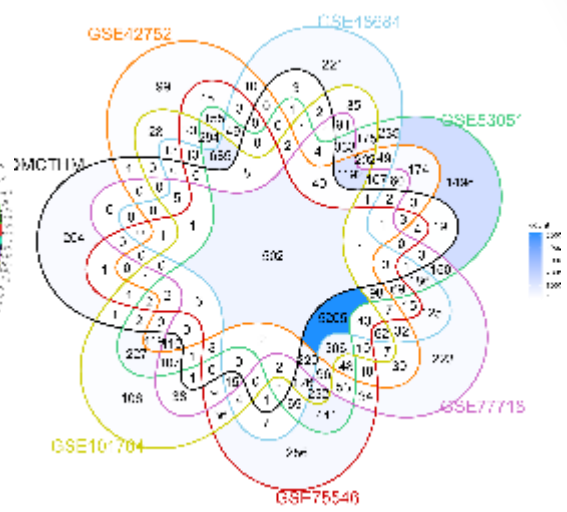
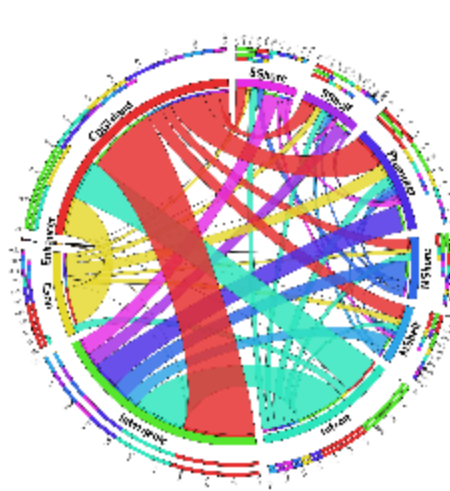
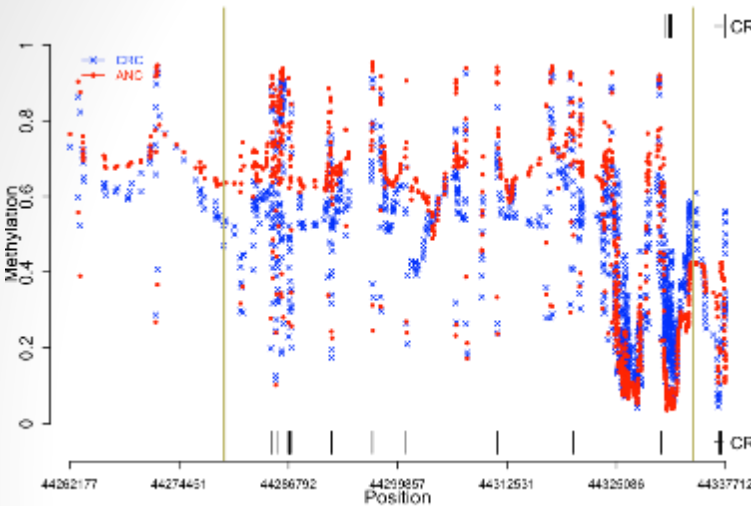

# Advanced Numerical Methods for Moving Domain/Interface Multi-Physics Problems

**Dr. Pengtao Sun**

Professor

Department of Mathematical Sciences

Email: [pengtao.sun@unlv.edu](mailto:pengtao.sun@unlv.edu) ; URL: <https://faculty.unlv.edu/sun/>

## Expertise

- Numerical Solutions of Partial Differential Equations (PDE)
- Numerical Analysis (Well-posedness, Stability, Convergence)
- Finite Element/Volume/Difference Methods
- Scientific and Engineering Computing
- Fluid-Structure Interaction (FSI) Modeling and Simulation
- Fuel Cell Dynamics, Fluid Dynamics, Electrohydrodynamics



# Fluid-Hydro Turbine Interaction Problems

- Hydroelectric power generating system produces renewable energy and remains crucial for society and industry. The most significant part of this system is the hydro turbine interacting with the water flow, which involves elastic solid materials and viscous fluids and belongs to the category of fluid-structure interaction (FSI). The developments of mathematical models and numerical methodologies are critical in practice for efficient simulations of the hydro turbine, which in turn guides the design and evaluation.
- We approach the challenges in different aspects. First, based on the observation that the hydro turbine, although exhibiting large rotations, has relatively small deformation, we develop linearized elasticity equations that alleviate the burden on nonlinear solver and improves the well-posedness of spatial discretization. Second, we propose a new approach to solve the arbitrary Lagrangian-Eulerian mesh motion for rotating structure. Moreover, we analyzed the well-posedness and convergence of the finite element discretization and demonstrated the discretization is solver friendly.

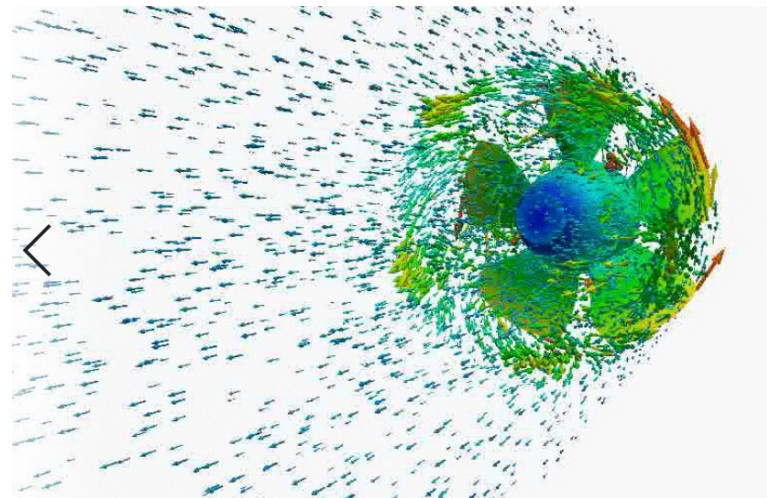
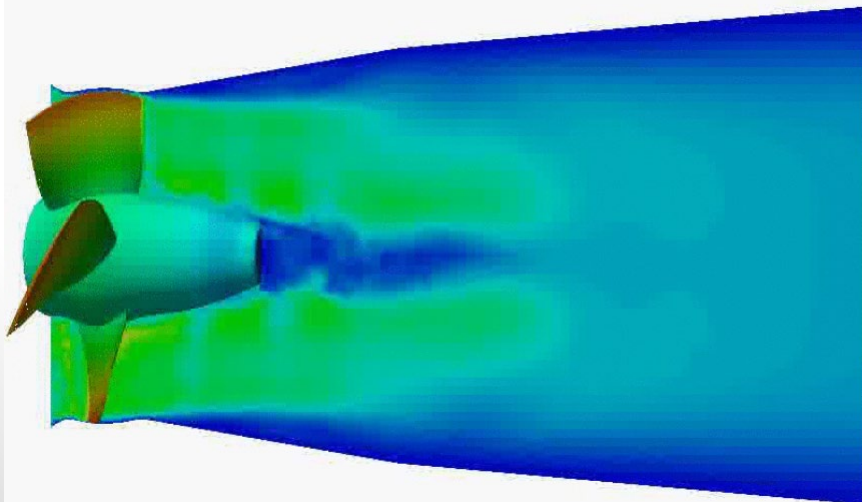

# Hemodynamic Fluid-Structure Interaction (FSI) Problems

- FSI simulation has become the most promising solution method to solve the hemodynamic problem existing in the clinical cardiovascular system. However, the complexity of cardiovascular environment, the artificial heart pump model, the vascular rupture, the aneurysm progression and the aortic dissection cause the deficiency of the existing FSI simulation package towards the clinical demands.
- We devoted our research to the new modeling and numerical techniques for the bloodstream-vascular-stent graft/artificial heart pump interaction problems, aiming at overcoming numerical difficulties and challenges, and developed advanced numerical methodologies to improve the efficiency and accuracy of corresponding FSI simulations. and to deliver more instructive numerical results to medical professionals for helping out patients on an efficient and accurate diagnosis and treatment.

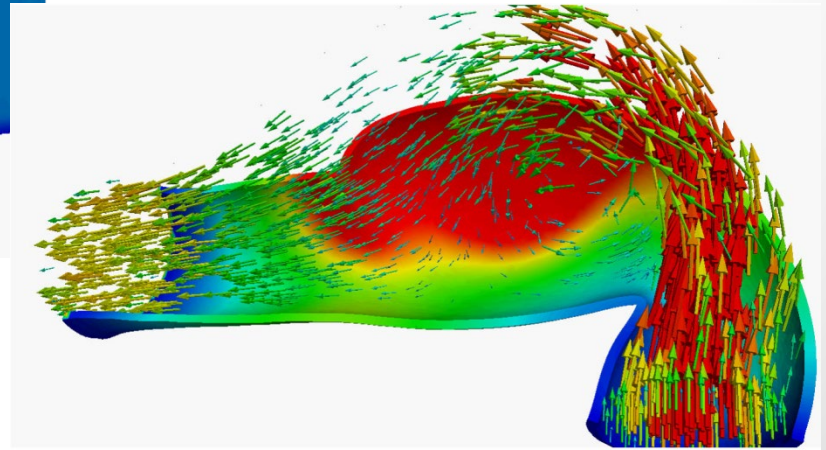
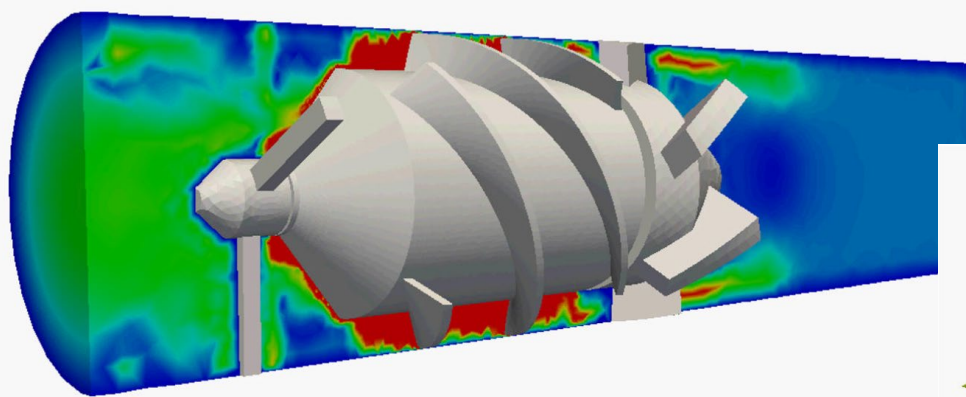

# Applied and Pure Mathematics

- **Dr. Zhijian Wu**
- Professor
- Department of Mathematical Sciences
- Email: [zhijian.wu@unlv.edu](mailto:zhijian.wu@unlv.edu)
- Website: <https://www.unlv.edu/people/zhijian-wu>



## Expertise

- Harmonic Analysis, Holomorphic Function Spaces, and Operator Theory.
- Optimal Strategies in Mathematical Finance.